

17 o. Abb. / no ill.
Isolatorsatz
Insulator set

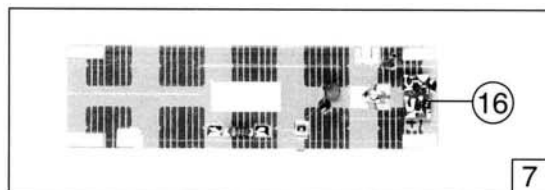

Pos. N.C.	Text	Art.-Nr.	Preis- gruppe
1	Stromabnehmer <i>Pantograph</i>	85287	38
2	Schraube M 1,6 x 5 <i>Screw M 1,6 x 5</i>	85692	2
3	Schraube M 2 x 5 <i>Screw M 2 x 5</i>	85715	2
4	Schraube M 1,6 x 6 <i>Screw M 1,6 x 6</i>	85811	2
5	Isolierhülse <i>Insulating tube</i>	86111	2
6	Feder <i>Spring</i>	86215	2
7	Platine komplett <i>Printed circuit assembly</i>	87799	43
8	Umschaltkontakt <i>Switch contact</i>	89709	2
9	Schaltbolzen <i>Switch pin</i>	89721	9
10	Kontaktstreifen <i>Contact strip</i>	89776	4
11	Schaltkontakt für 43005 <i>Switch contact for 43005</i>	89961	4
12	Dachleitungssatz <i>Roof conducting wire set</i>	93430	12
13	Leuchstab <i>Light transmissions bar</i>	93434	4
14	Platinenhalter <i>Printed circuit holder</i>	93436	2
15	Sofitte <i>Tubular-lamp</i>	93517	10
16	Brückenstecker <i>Connector</i>	100644	7
17	Isolatorsatz <i>Insulator set</i>	101764	34
18	Dach komplett für 43005 <i>Roof assembly for 43005</i>	101765	52
19	Gehäuse komplett für 43005 Betr. Nr. 421 179-3 <i>Body assembly for 43005</i> Betr. No. 421 179-3	101766	60
20	Fenstersatz für 43005 <i>Glazing set for 43005</i>	101767	25
21	Dachleitung lackiert für 43005 <i>Roof wire for 43005</i>	101768	3
22	Stromabnehmerisolator <i>Pantograph insulator</i>	101769	2
23	Inneneinrichtungssatz für 43005 <i>Interior set for 43005</i>	101816	12
24	Oberleitungsverbinder für 43006 <i>Overhead supply connector for 43006</i>	89778	4
25	Dach komplett für 43006 <i>Roof assembly for 43006</i>	101833	62
26	Gehäuse komplett für 43006 Betr. Nr. 421 171-0 <i>Body assembly for 43006</i> Betr. No. 421 171-0	101834	60
27	Fenstersatz Motorwagen, Steuerwagen für 43006 <i>Glazing set for 43006</i>	101835	25
28	Inneneinrichtungssatz für 43006 <i>Interior set for 43006</i>	101836	12
29	Dachleitung lackiert für 43006 <i>Roof wire for 43006</i>	101837	3

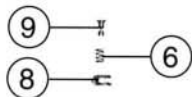
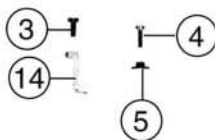
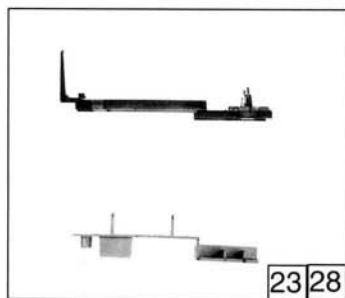
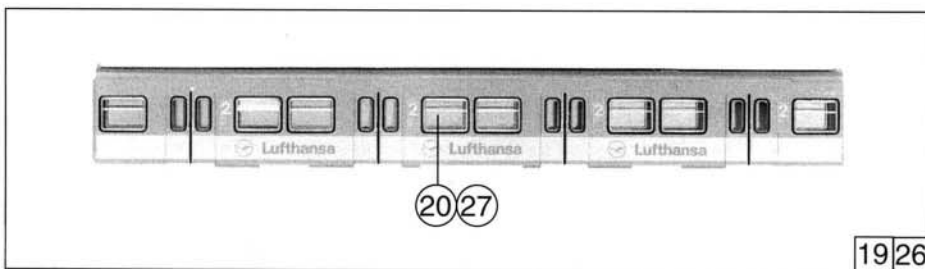
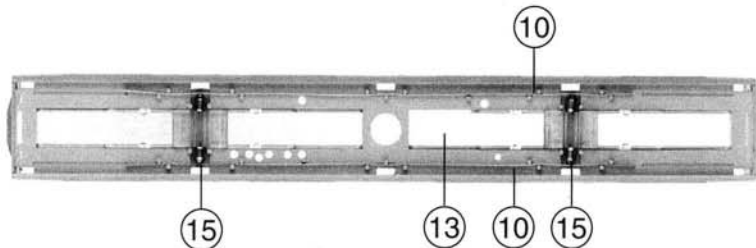
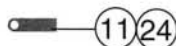
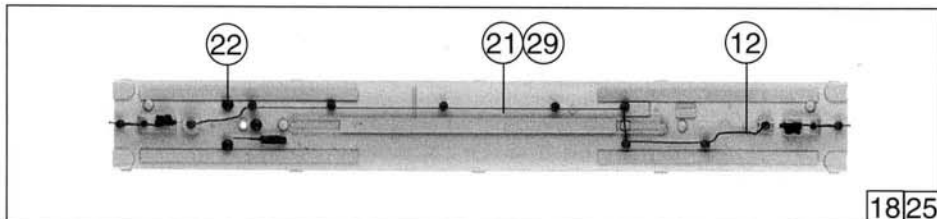
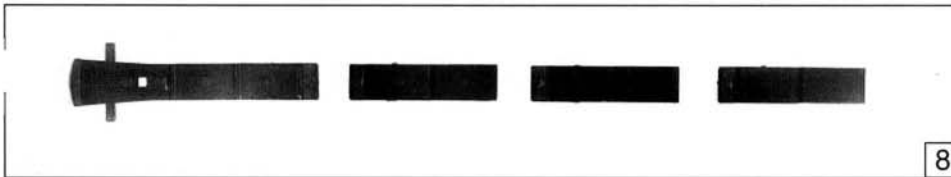
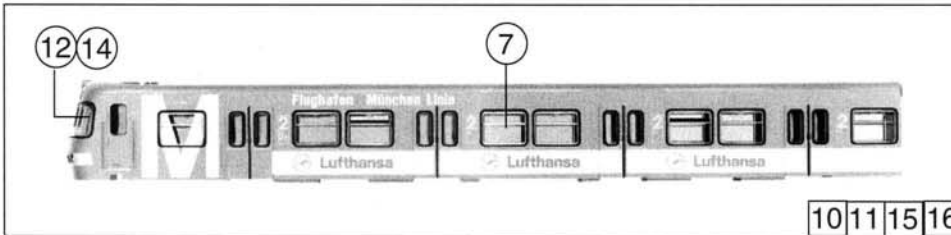
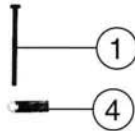
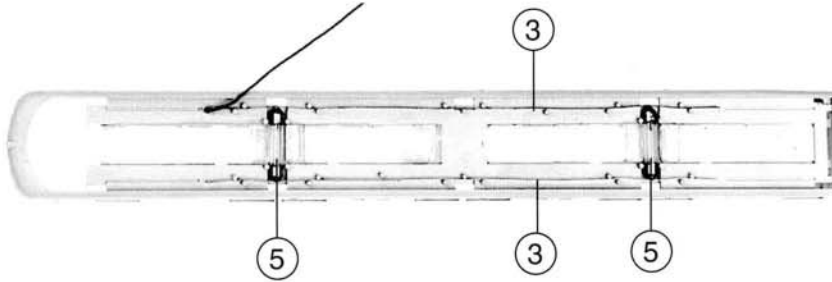
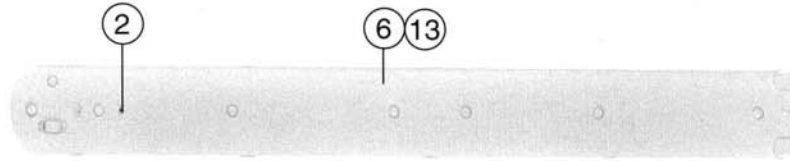

Pos. Nr.	Text	Art.-Nr.	Preisgruppe
1	Schraube M 2 x 25 <i>Screw M 2 x 25</i>	85759	2
2	Lokpfeife <i>Loco whistle</i>	88002	6
3	Kontaktstreifen <i>Contact strip</i>	89776	4
4	Löffane <i>Contact</i>	89962	2
5	Sofitte <i>Tubular lamp</i>	93517	10
6	Dach für 43005 <i>Roof for 43005</i>	101778	25
7	Fenstersatz <i>Glazing set</i>	101779	25
8	Lichtleitstäbesatz 1 <i>Light transmissions bar set 1</i>	101780	16
9	Lichtleitstäbesatz 2 <i>Light transmissions bar set 2</i>	101781	16
10	Gehäuse komplett für 43005 St.w.1 <i>Body assembly 1 for 43005</i> Betr. Nr. 420 179-4	101782	60
11	Gehäuse komplett für 43005 St.w. 2 <i>Body assembly 2 for 43005</i> Betr. Nr. 420 679-3	101783	60
12	Stirfenster für 43005, St.w. 1; 2; <i>Front glazing for 1; 2; 43005</i>	101784	10
13	Dach für 43006 <i>Roof wire for 43006</i>	101839	25
14	Stirfenstersatz für 43006 <i>Glazing set for 43006</i>	101840	25
15	Gehäuse 1 komplett für 43006 <i>Body 1 assembly for 43006</i> Betr. Nr. 420 171-1	101843	60
16	Gehäuse 2 komplett für 43006 <i>Body 2 assembly for 43006</i> Betr. Nr. 420 671-0	101844	60

Pos. Nr.	Text	Art.-Nr.	Preis-gruppe
1	Schraube M 2 x 5 <i>Screw M 2 x 5</i>	85715	2
2	Schraube M 2,2 x 9,5 <i>Screw M 2,2 x 9,5</i>	85808	2
3	Platine komplett <i>Printed circuit assembly</i>	87692	22
4	Scharfenbergkupplung <i>Scharfenberg coupler</i>	89214	3
5	Gewicht <i>Weight</i>	93416	14
6	Glühlampe <i>Lamp</i>	93518	12
7	Glühlampe rot <i>Lamp red</i>	93522	14
8	Kupplung <i>Coupling</i>	101785	3
9	Radsatz <i>Wheelset</i>	101786	16
10	Abdeckplatte vorne <i>Cover plate front</i>	101787	8
11	Abdeckplatte hinten <i>Cover plate rear</i>	101788	6
12	Abdeckplatte <i>Cover plate</i>	101789	2
13	Drehgestellblende 1 <i>Bogie frame 1</i>	101790	23
14	Drehgestellblende 2 <i>Bogie frame 2</i>	101791	23
15	Drehgestell 1 komplett <i>Bogie 1 assembly</i>	101792	40
16	Drehgestell 2 komplett <i>Bogie 2 assembly</i>	101793	40
17	Bodenplatte 1 für 43005 <i>Main frame 1 for 43005</i>	101794	30
18	Inneneinrichtungssatz St.w. <i>Interior set</i>	101815	30
19	Drehschemel mit Zapfen <i>Balance holder with pin</i>	101846	4
20	Drehschemel ohne Zapfen <i>Balance holder without pin</i>	101847	4
21	Bodenplatte 1 für 43006 <i>Main frame 1 for 43006</i>	101848	30
22	Bodenplatte 2 für 43006 <i>Main frame 2 for 43006</i>	101849	30
23	Bodenplatte 2 für 43005 <i>Main frame 2 for 43005</i>	101850	30

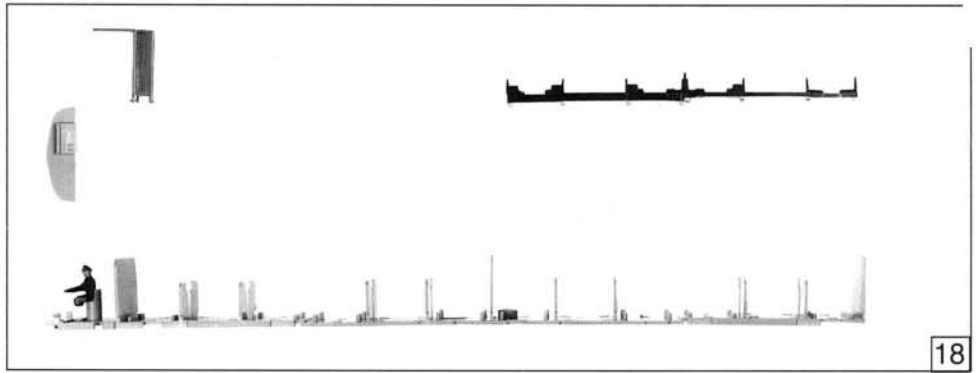

18

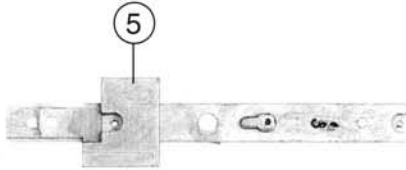
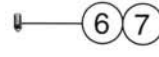

4 o. Abb. / no ill.
Scharfenbergkupplung
Scharfenberg coupler

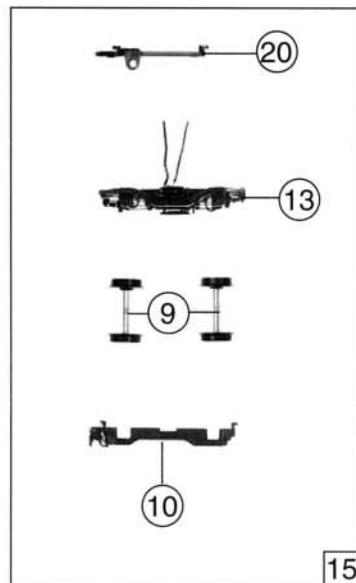
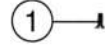
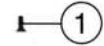
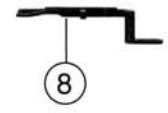
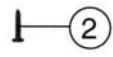

15

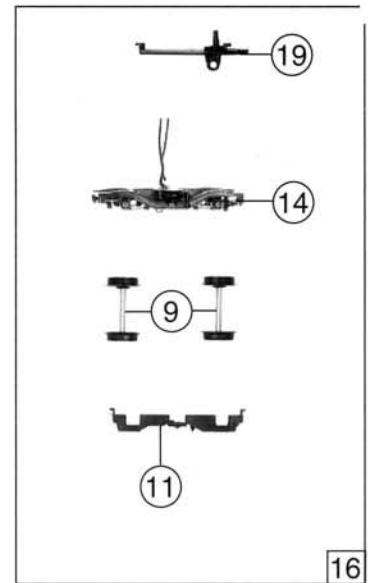

16

Pos. Nr.	Text	Art.-Nr.	Preisgruppe
1	Motor mit Schwungscheibe <i>Motor with flywheel</i>	85051	57
2	Haltring <i>Traction tyre</i>	85602	17
3	Schraube M 2 x 5 <i>Screw M 2 x 5</i>	85715	2
4	Zahnrad z=12l; m 0,4 <i>Gear T=12l; m 0,4</i>	86430	2
5	Zahnrad z=19r; m 0,4 <i>Gear T=19r; m 0,4</i>	86431	2
6	Zahnrad z=24r; m 0,4 <i>Gear T=24r; m 0,4</i>	86432	2
7	Zahnrad z=19l; m 0,4 <i>Gear T=19l; m 0,4</i>	86433	2
8	Schnecke <i>Worm</i>	86712	4
9	Kardanwelle <i>Cardan shaft</i>	87056	3
10	Kardanschale kurz <i>Cardan bearing short</i>	87057	2
11	Kardanschale lang <i>Cardan bearing short</i>	87076	2
12	Radkontakt <i>Wheel contact</i>	89858	3
13	Motorhalter <i>Motor holder</i>	93438	28
14	Getriebeklammer <i>Gear clamp</i>	93442	2
15	Getriebekasten links <i>Gear left</i>	93443	10
16	Getriebedeckel rechts <i>Gear cover right</i>	93444	10
17	Schneckensatz <i>Worm set</i>	101770	24
18	Kupplungsführung <i>Coupling</i>	101771	3
19	Drehgestellblende <i>Bogie frame</i>	101772	12
20	Getriebeabdeckung <i>Gear cover</i>	101773	5
21	Bodenplatte Motorwagen für 43005 <i>Main frame for 43005</i>	101774	30
22	Drehgestell komplett <i>Bogie assembly</i>	101775	51
23	Radsatz mit Haltring <i>Wheelset with traction tyre</i>	101776	20
24	Radsatz <i>Wheelset</i>	101777	18
25	Zurüstbeutel <i>Bag with accessories</i>	101817	8
26	Bodenplatte für 43006 <i>Main frame for 43006</i>	101838	30
27	Wippe 1 <i>Balance holder 1</i>	101845	3
28	Wippe 2 <i>Balance holder 2</i>	105006	3

